

Handleiding Bamboe Pergola Moso 3x3

Manual Bamboo Pergola Moso 3x3

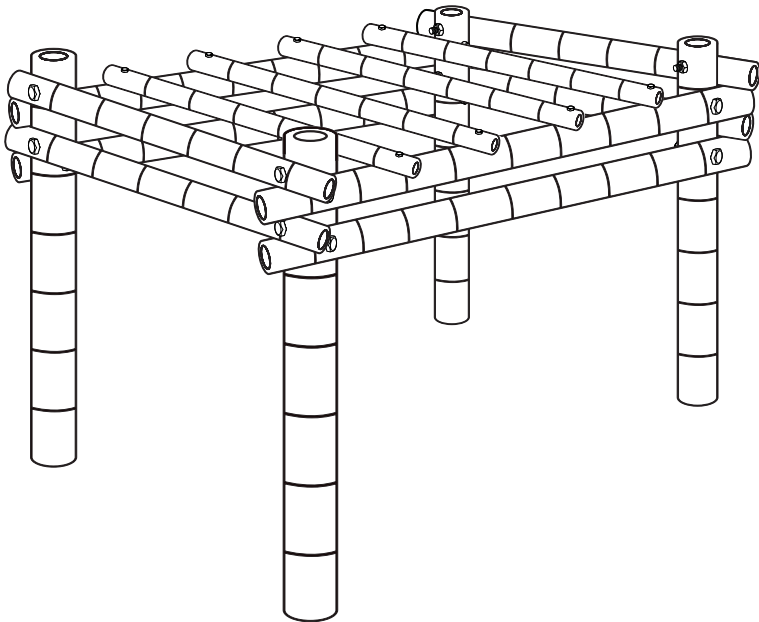

Gereedschap / Tools

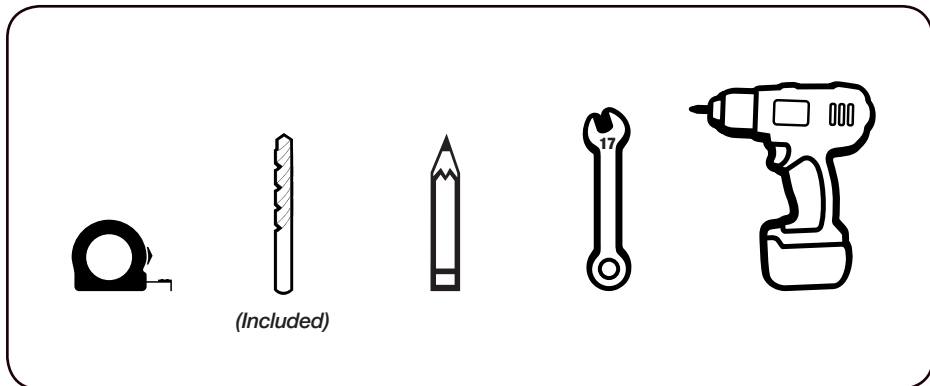

Materiaal / Material

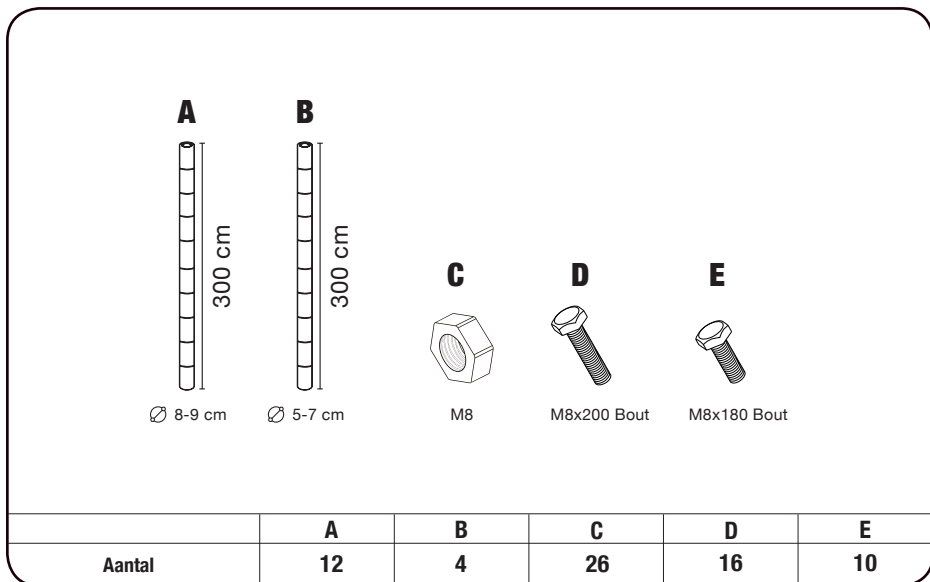

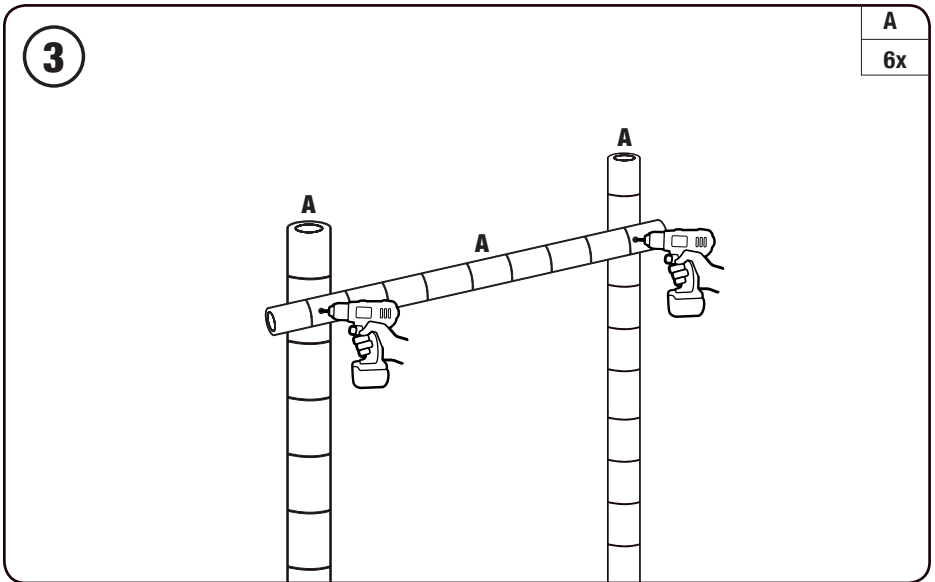
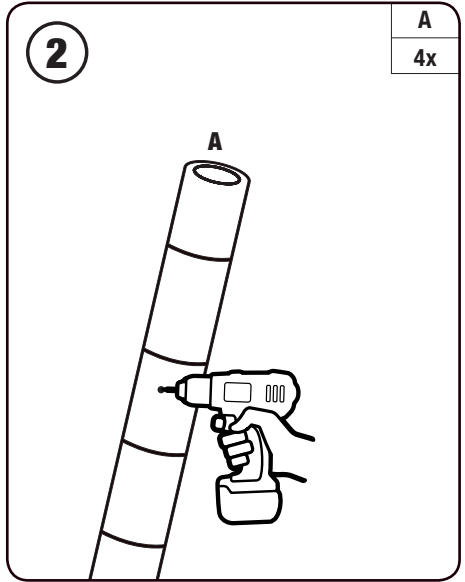
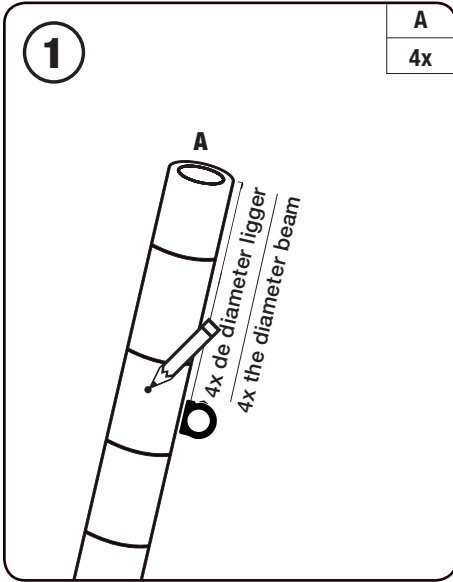

4

A	C	D
6x	4x	4x

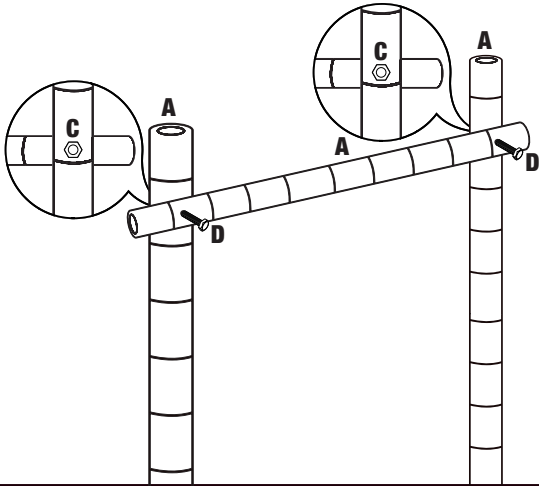

5

A
2x

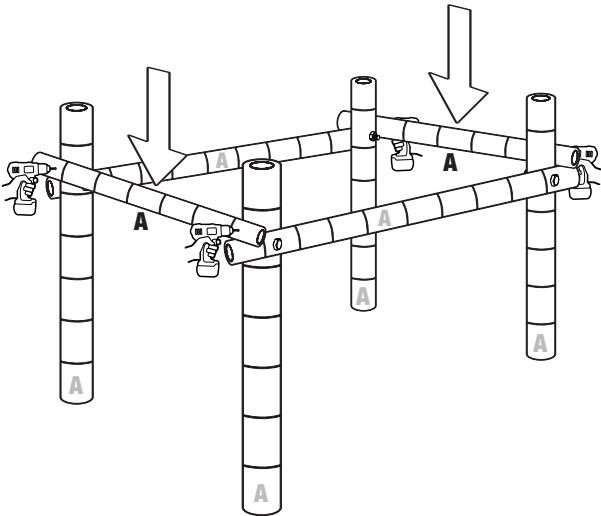

6

A	C	D
2x	4x	4x

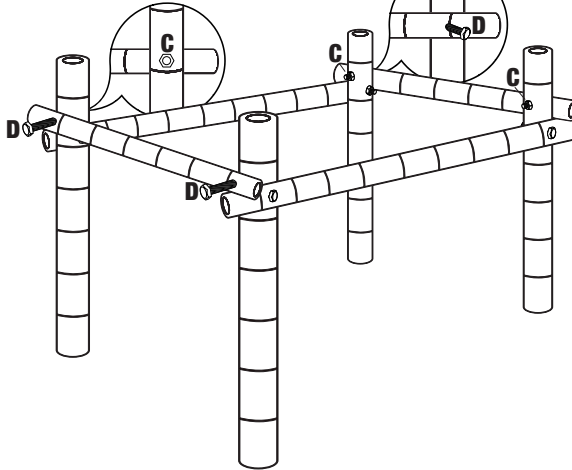

7

A
2x

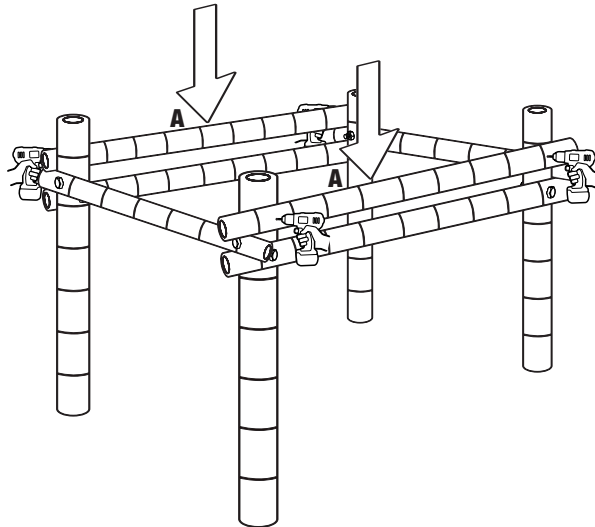

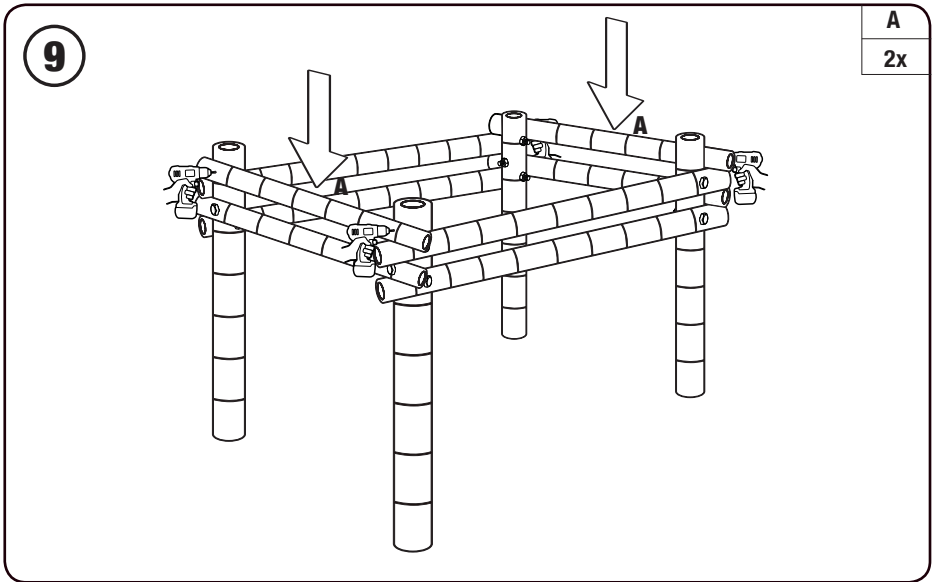
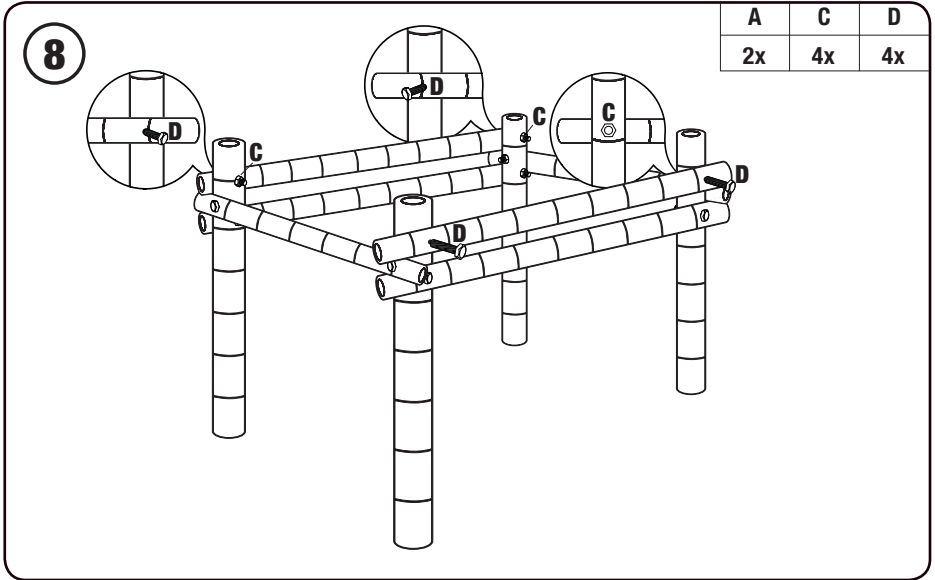

10

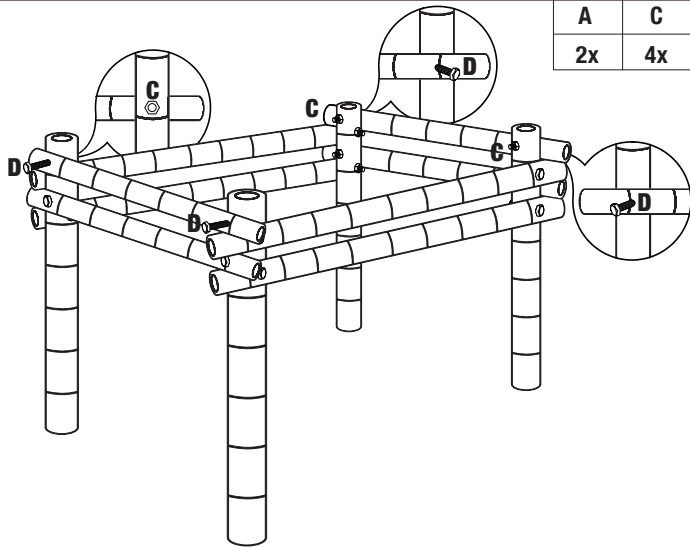

11

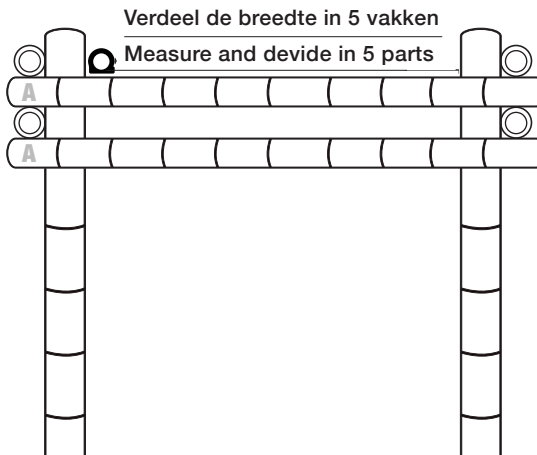

12

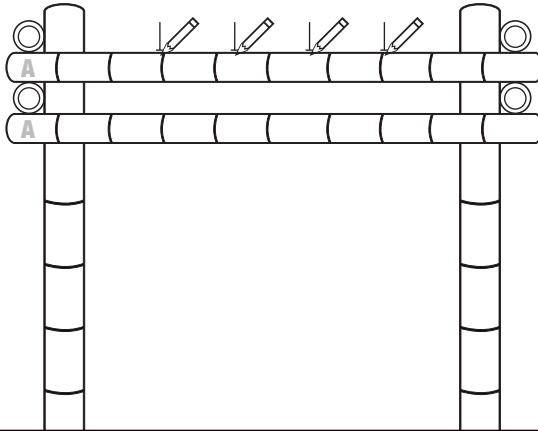

13

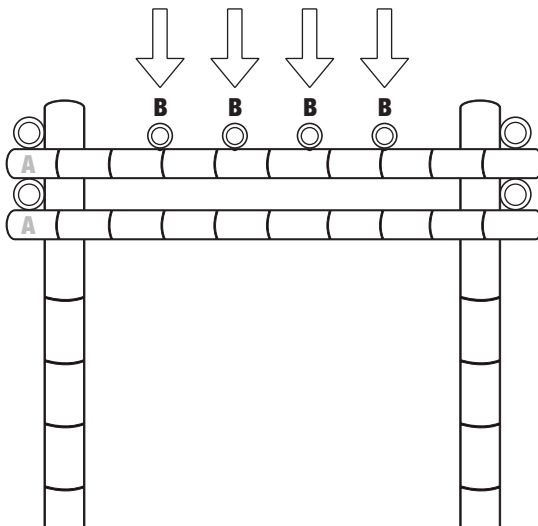

14

B
4x

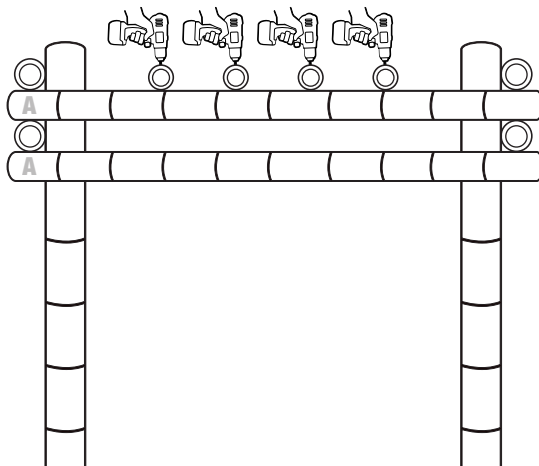

15

B	C	E
4x	8x	8x

